

## DS1489/DS1489A Quad Line Receiver

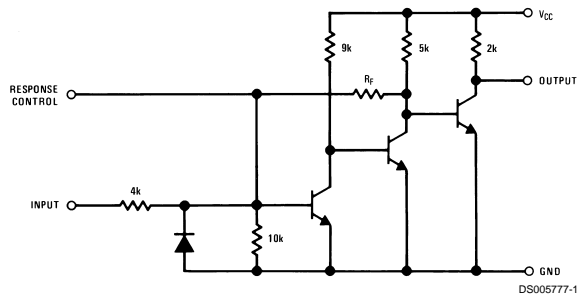
### General Description

The DS1489/DS1489A are quad line receivers designed to interface data terminal equipment with data communications equipment. They are constructed on a single monolithic silicon chip. These devices satisfy the specifications of EIA Standard RS-232D. The DS1489/DS1489A meet and exceed the specifications of MC1489/MC1489A and are pin-for-pin replacements.

### Features

- Four separate receivers per package
- Programmable threshold
- Built-in input threshold hysteresis
- "Fail safe" operating mode: high output for open inputs
- Inputs withstand  $\pm 30V$

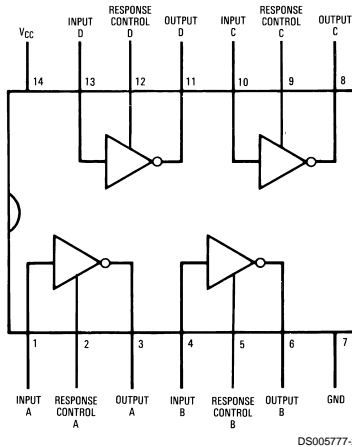
### Schematic and Connection Diagrams



(1/4 of unit shown)

DS1489:  $R_F = 10k$   
DS1489A:  $R_F = 2k$

### Dual-In-Line Package



### Top View

Order Number DS1489M, DS1489N  
DS1489AM or DS1489AN  
See NS Package Number M14A or N14A

## AC Test Circuit and Voltage Waveforms

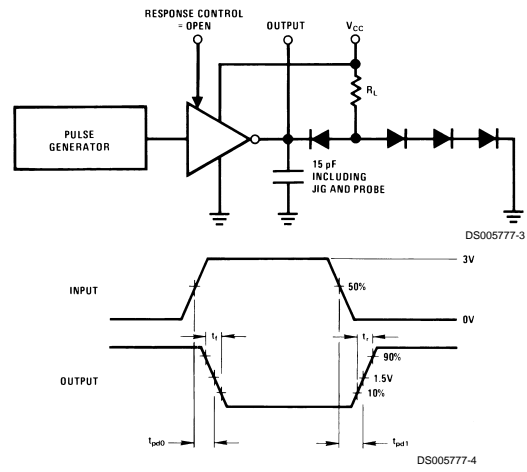


FIGURE 1.

## Absolute Maximum Ratings (Note 2)

If Military/Aerospace specified devices are required, please contact the National Semiconductor Sales Office/Distributors for availability and specifications.

Power Supply Voltage	10V
Input Voltage Range	±30V
Output Load Current	20 mA
Power Dissipation (Note 3)	1W
Operating Temperature Range	0°C to +75°C

Storage Temperature Range -65°C to +150°C

Maximum Power Dissipation (Note 1) at 25°C

Molded DIP Package	1207 mW
SO Package	1042 mW

Lead Temperature (Soldering, 4 sec.) 260°C

Note 1: Derate molded DIP package 9.7 mW/°C above 25°C; derate SO package 8.33 mW/°C above 25°C.

## Electrical Characteristics (Notes 3, 4, 5)

DS1489/DS1489A: The following apply for  $V_{CC} = 5.0V \pm 1\%$ ,  $0^\circ C \leq T_A \leq +75^\circ C$  unless otherwise specified.

Symbol	Parameter	Conditions	Min	Typ	Max	Units		
$V_{TH}$	Input High Threshold Voltage	$V_{OUT} \leq 0.45V$ , $I_{OUT} = 10 \text{ mA}$	DS1489	$T_A = 25^\circ C$	1.0	1.25	1.5	V
					0.9		1.6	V
		DS1489A	$T_A = 25^\circ C$	1.75	2.00	2.25	V	
				1.55		2.40	V	
$V_{TL}$	Input Low Threshold Voltage	$V_{OUT} \geq 2.5V$ , $I_{OUT} = -0.5 \text{ mA}$	$T_A = 25^\circ C$	0.75	1.00	1.25	V	
				0.65		1.35	V	
$I_{IN}$	Input Current	$V_{IN} = +25V$	+3.6	+5.6	+8.3	mA		
		$V_{IN} = -25V$	-3.6	-5.6	-8.3	mA		
		$V_{IN} = +3V$	+0.43	+0.53		mA		
		$V_{IN} = -3V$	-0.43	-0.53		mA		
$V_{OH}$	Output High Voltage	$I_{OUT} = -0.5 \text{ mA}$	$V_{IN} = 0.75V$	2.6	3.8	5.0	V	
			Input = Open	2.6	3.8	5.0	V	
$V_{OL}$	Output Low Voltage	$V_{IN} = 3.0V$ , $I_{OUT} = 10 \text{ mA}$		0.33	0.45	V		
$I_{SC}$	Output Short Circuit Current	$V_{IN} = 0.75V$		-3.0		mA		
$I_{CC}$	Supply Current	$V_{IN} = 5.0V$		14	26	mA		
$P_d$	Power Dissipation	$V_{IN} = 5.0V$		70	130	mW		

## Switching Characteristics

$V_{CC} = 5V$ ,  $T_A = 25^\circ C$

Symbol	Parameter	Conditions	Min	Typ	Max	Units
$t_{pd1}$	Input to Output "High" Propagation Delay	$R_L = 3.9k$ , (Figure 1) (AC Test Circuit)		28	85	ns
$t_{pd0}$	Input to Output "Low" Propagation Delay	$R_L = 390\Omega$ , (Figure 1) (AC Test Circuit)		20	50	ns
$t_r$	Output Rise Time	$R_L = 3.9k$ , (Figure 1) (AC Test Circuit)		110	175	ns
$t_f$	Output Fall Time	$R_L = 390\Omega$ , (Figure 1) (AC Test Circuit)		9	20	ns

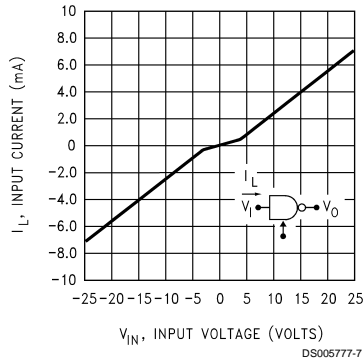
Note 2: "Absolute Maximum Ratings" are those values beyond which the safety of the device cannot be guaranteed. Except for "Operating Temperature Range" they are not meant to imply that the devices should be operated at these limits. The table of "Electrical Characteristics" provides conditions for actual device operation.

Note 3: Unless otherwise specified min/max limits apply across the 0°C to +75°C temperature range for the DS1489 and DS1489A.

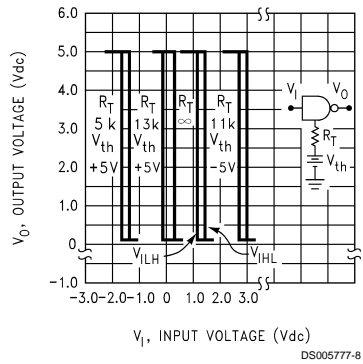
Note 4: All currents into device pins shown as positive, out of device pins as negative, all voltages referenced to ground unless otherwise noted. All values shown as max or min on absolute value basis.

Note 5: These specifications apply for response control pin = open.

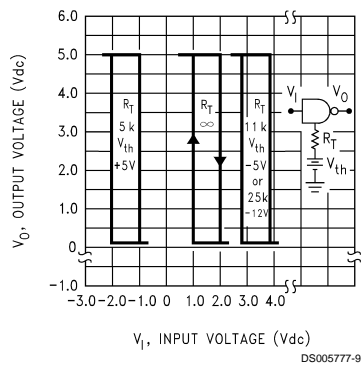
**Typical Characteristics**  $V_{CC} = 5.0V$ ,  $T_A = +25^\circ C$  unless otherwise noted



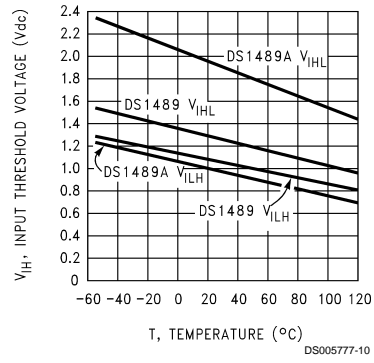
**FIGURE 2. Input Current**



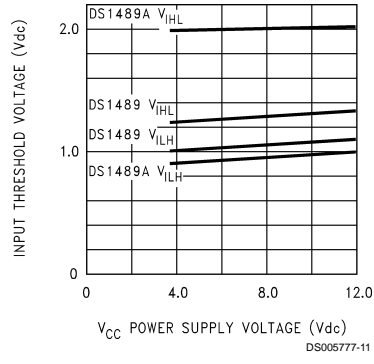
**FIGURE 3. DS1489 Input Threshold Voltage Adjustment**



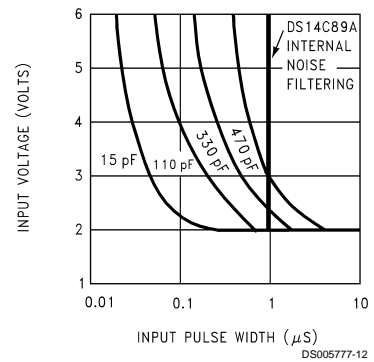
**FIGURE 4. DS1489A Input Threshold Voltage Adjustment**



**FIGURE 5. Input Threshold Voltage vs Temperature**

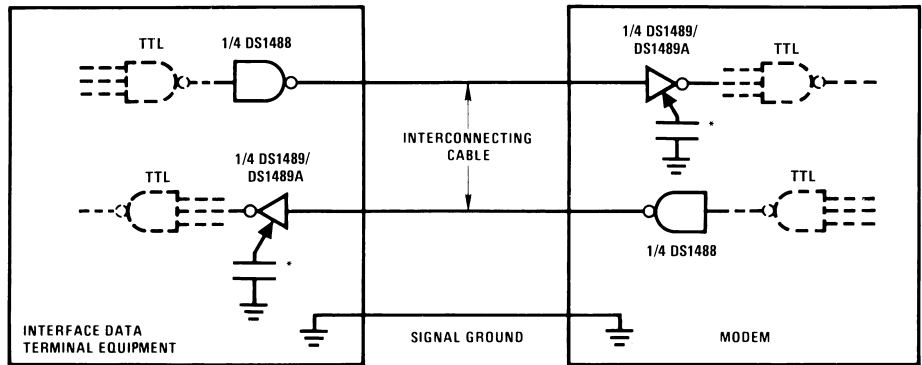


**FIGURE 6. Input Threshold vs Power Supply Voltage**



**FIGURE 7. Noise Rejection vs Capacitance for DS1489A**

## Typical Application Information

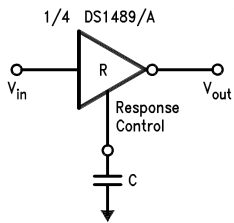


DS005777-5

\*Optional for noise filtering.

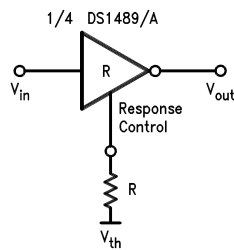
### Applications Using the Response Control Pin

#### Noise Filter See Figure 7



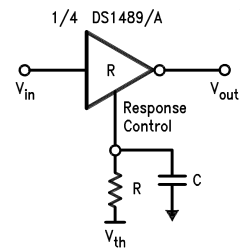
DS005777-13

#### Threshold Shift See Figures 3, 4



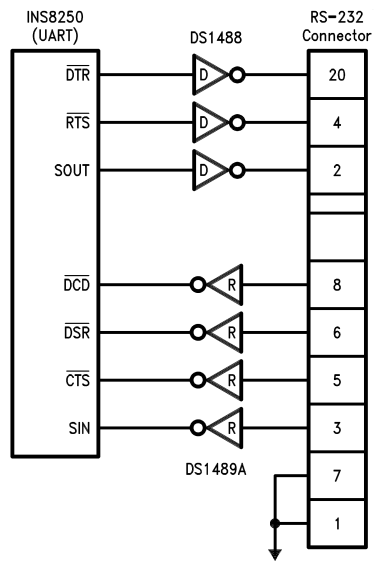
DS005777-14

#### Noise Filter and Threshold Shift See Figures 3, 4, 7

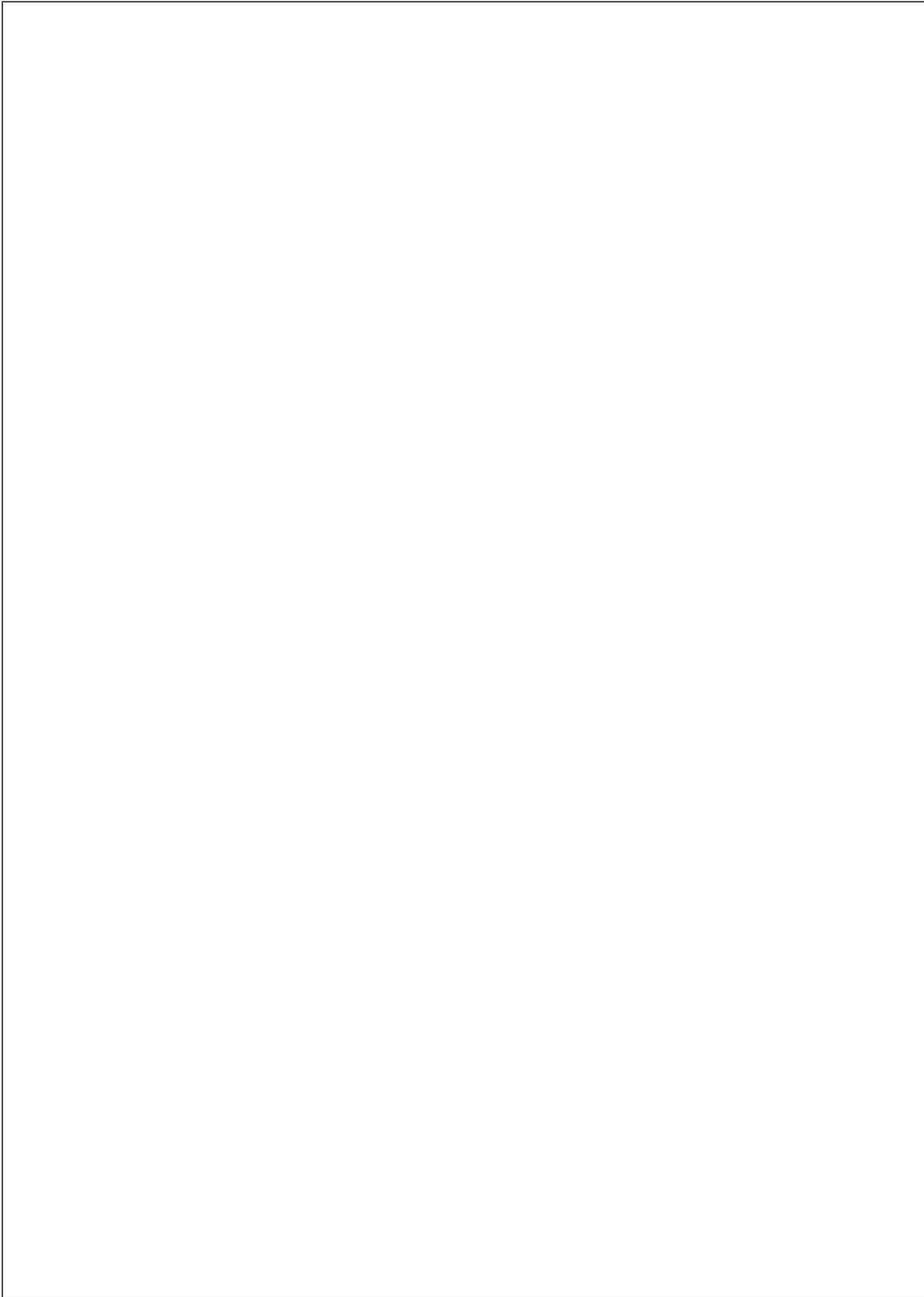


DS005777-15

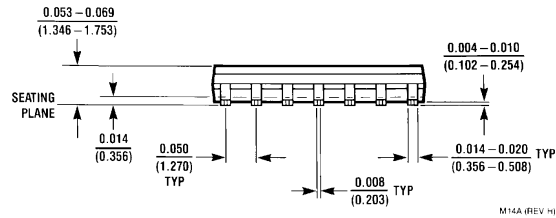
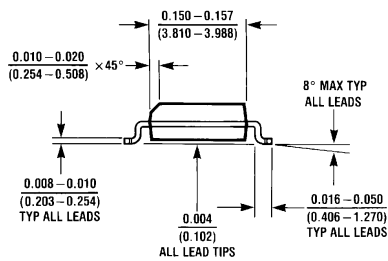
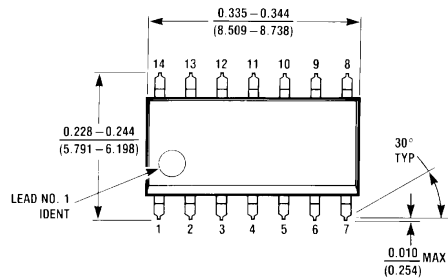
### Application of DS1488, DS1489A and INS8250



DS005777-16

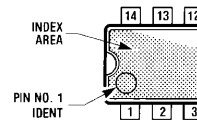
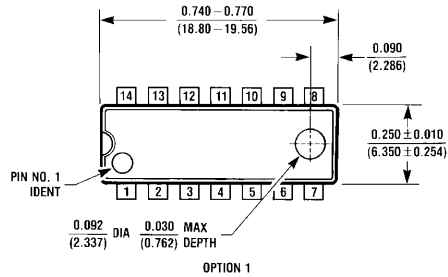


**Physical Dimensions** inches (millimeters) unless otherwise noted



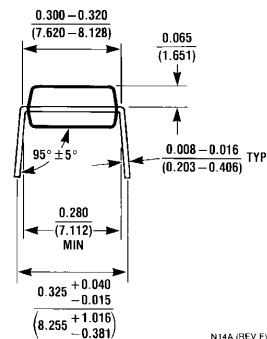
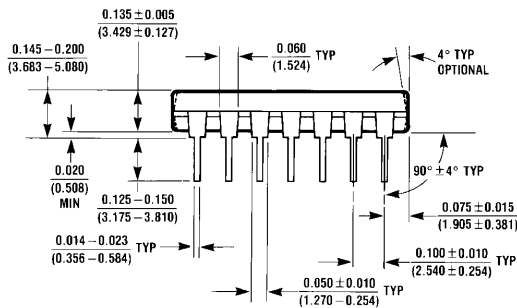
M14A (REV HI)

**SO Package (M)**  
Order Number DS1489M or DS1489AM  
NS Package Number M14A



OPTION 1

OPTION 02



N14A (REV F)

**Molded Dual-In-Line Package (N)**  
Order Number DS1489N or DS1489AN  
NS Package Number N14A

### LIFE SUPPORT POLICY

NATIONAL'S PRODUCTS ARE NOT AUTHORIZED FOR USE AS CRITICAL COMPONENTS IN LIFE SUPPORT DEVICES OR SYSTEMS WITHOUT THE EXPRESS WRITTEN APPROVAL OF THE PRESIDENT OF NATIONAL SEMICONDUCTOR CORPORATION. As used herein:

1. Life support devices or systems are devices or systems which, (a) are intended for surgical implant into the body, or (b) support or sustain life, and whose failure to perform when properly used in accordance with instructions for use provided in the labeling, can be reasonably expected to result in a significant injury to the user.
2. A critical component in any component of a life support device or system whose failure to perform can be reasonably expected to cause the failure of the life support device or system, or to affect its safety or effectiveness.



**National Semiconductor Corporation**  
Americas  
Tel: 1-800-272-9959  
Fax: 1-800-737-7018  
Email: support@nsc.com

[www.national.com](http://www.national.com)

**National Semiconductor Europe**  
Fax: +49 (0) 1 80-530 85 86  
Email: europe.support@nsc.com  
Deutsch Tel: +49 (0) 1 80-530 85 85  
English Tel: +49 (0) 1 80-532 78 32  
Français Tel: +49 (0) 1 80-532 93 58  
Italiano Tel: +49 (0) 1 80-534 16 80

**National Semiconductor Asia Pacific Customer Response Group**  
Tel: 65-2544466  
Fax: 65-2504466  
Email: sea.support@nsc.com

**National Semiconductor Japan Ltd.**  
Tel: 81-3-5620-6175  
Fax: 81-3-5620-6179